

TOSHIBA Intelligent Power Device Silicon Monolithic Power MOS Integrated Circuit

TPD1024S

Low-side Power Switch for Motors, Solenoids, and Lamp Drivers

The TPD1024S is a monolithic power IC for low-side switches. The IC has a vertical MOS FET output which can be directly driven from a CMOS or TTL logic circuit (e.g., an MPU).

The device is equipped with an intelligent self-protection function.

Features

- A monolithic power IC with a new structure combining a control block and a vertical power MOS FET (π -MOS) on a single chip
- Can directly drive a power load from a CMOS logic.
- Built-in protection against overvoltage, load short-circuiting, and thermal shutdown
- Low on-resistance : $R_{DS(ON)} = 0.5 \Omega$ (max), (@ $V_{IN} = 5 V, T_j = 25^\circ C$)
- 3-pin power-molded package usable for surface mounting.

Pin Assignment

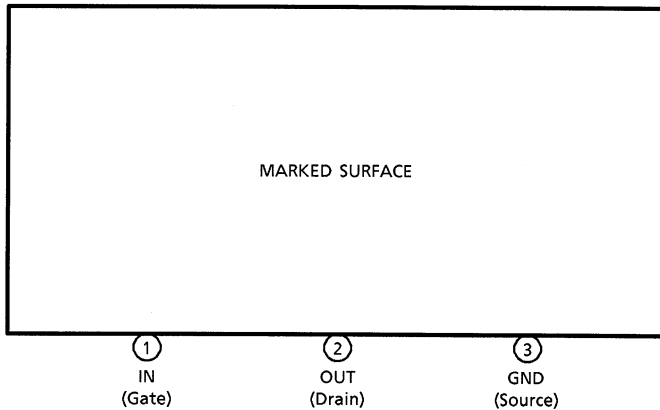

Note: Due to its MOS structure, this product is sensitive to static electricity.

Marking

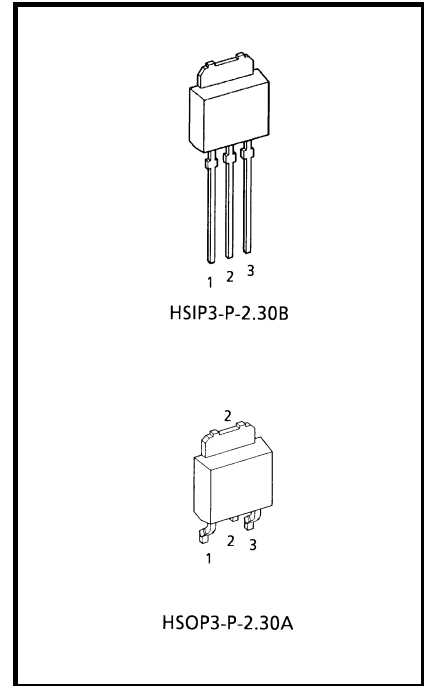
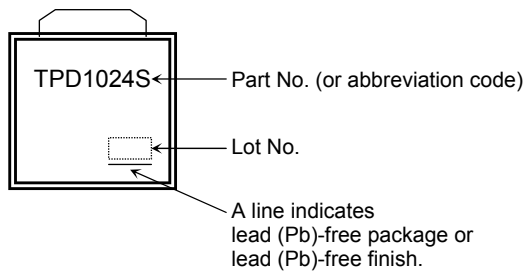

Weight	
HSIP3-P-2.30B	: 0.36 g (typ.)
HSOP3-P-2.30A	: 0.28 g (typ.)

Block Diagram

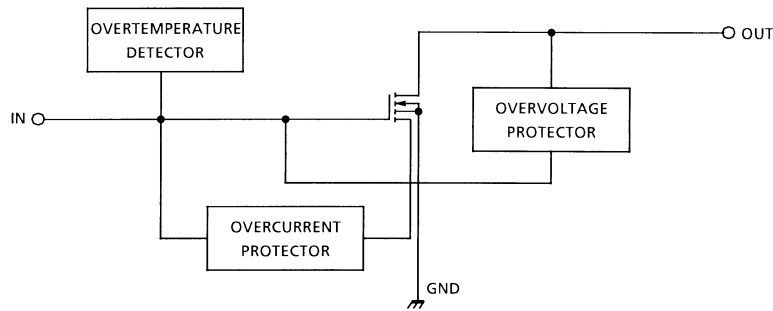

Pin Description

Pin No.	Symbol	Function
1	IN	Input pin. Input is CMOS-compatible, with pull-down resistor connected. Even if the input is open, output will not accidentally turn on.
2	OUT	Output pin. When current in excess of the typical current (3.5 A (typ.)) flows to the output pin, the current limiter operates to protect the IC.
3	GND	Ground pin.

Timing Chart

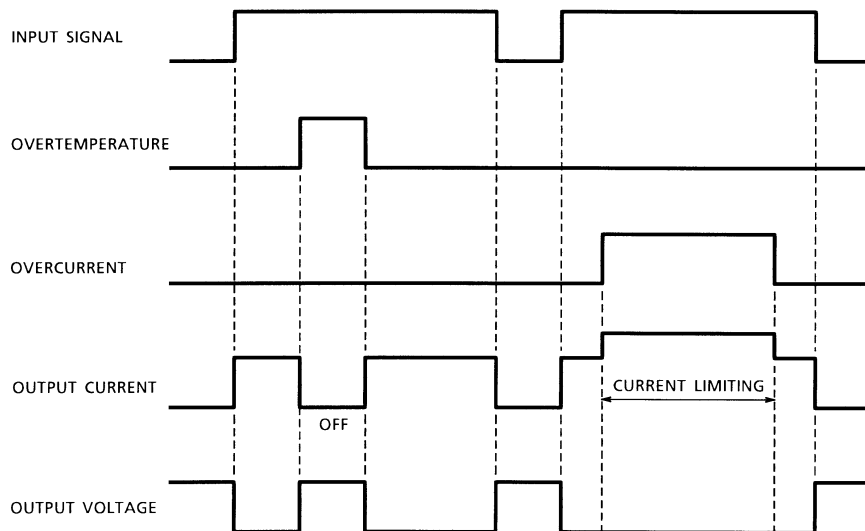

Absolute Maximum Ratings (Ta = 25°C)

Characteristic	Symbol	Rating	Unit	
Drain-source voltage	V_{DS} (DC)	40	V	
Output current	I_D	1.5	A	
Input voltage	V_{GS}	-0.5 ~ 6	V	
Power dissipation	P_D	Ta = 25°C	1	W
		Tc = 25°C	10	
Operating temperature	T_{opr}	-40 ~ 85	°C	
Junction temperature	T_j	150	°C	
Storage temperature	T_{stg}	-55 ~ 150	°C	

Note: Using continuously under heavy loads (e.g. the application of high temperature/current/voltage and the significant change in temperature, etc.) may cause this product to decrease in the reliability significantly even if the operating conditions (i.e. operating temperature/current/voltage, etc.) are within the absolute maximum ratings and the operating ranges.

Please design the appropriate reliability upon reviewing the Toshiba Semiconductor Reliability Handbook ("Handling Precautions"/Derating Concept and Methods) and individual reliability data (i.e. reliability test report and estimated failure rate, etc).

Electrical Characteristics (Tj = 25°C)

Characteristic	Symbol	Test Circuit	Test Condition	Min	Typ.	Max	Unit
Drain-source breakdown voltage	$V_{(BR)DSS}$	—	$V_{GS} = 0, I_D = 10 \text{ mA}$	40	—	—	V
Operating supply voltage	V_{DD} (OPR)	—	—	—	—	18	V
Current at output off	I_{DSS} (1)	—	$V_{GS} = 0, V_{DS} = 40 \text{ V}$	—	—	3	mA
	I_{DSS} (2)	—	$V_{GS} = 0, V_{DS} = 24 \text{ V}$	—	—	100	μA
Input threshold voltage	V_{th}	—	$V_{DS} = 10 \text{ V}, I_D = 1 \text{ mA}$	0.8	—	2.5	V
Input current	I_{GSS}	—	$V_{GS} = 5 \text{ V}$, at normal operation	—	—	300	μA
On resistance	R_{DS} (ON)	—	$V_{GS} = 5 \text{ V}, I_D = 1 \text{ A}$	—	—	0.5	Ω
Thermal shutdown temperature	T_S	—	—	—	160	—	°C
Overcurrent protection	I_S	—	$V_{DS} = 12 \text{ V}, V_{GS} = 5 \text{ V}$	—	3.5	—	A
Switching time	t_{ON}	1	$V_{DS} = 12 \text{ V}, V_{GS} = 5 \text{ V}$, $R_L = 12 \Omega$	—	50	—	μs
	t_{OFF}			—	10	—	μs
Diode forward voltage Between drain and source	V_{DSF}	—	$I_F = 1.5 \text{ A}$	—	0.9	1.8	V
Avalanche energy	E_A	—	L = 10 mH, Single pulse	30	—	—	mJ

Test Circuit 1

Switching Time

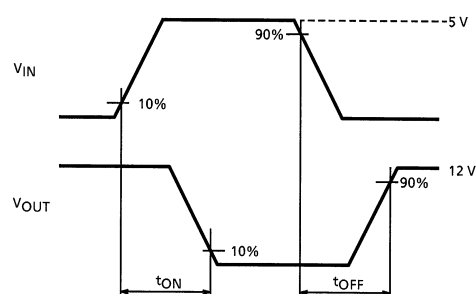
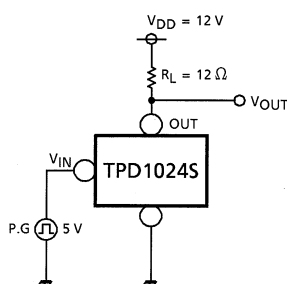

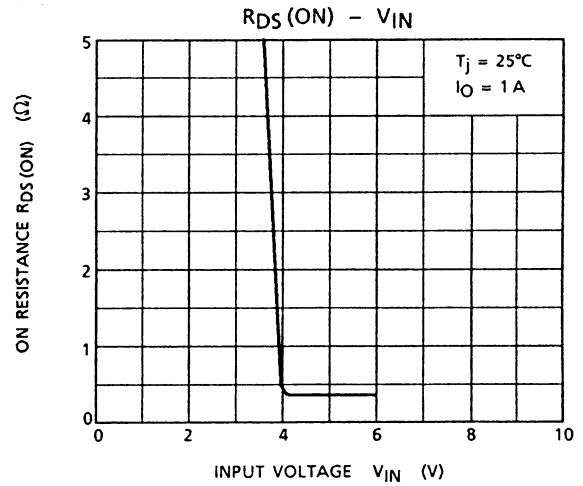
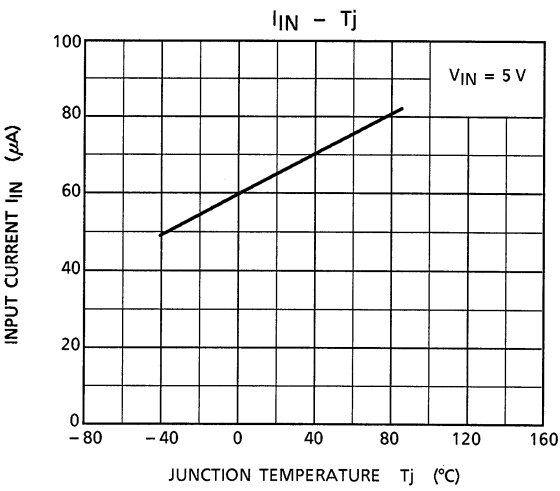
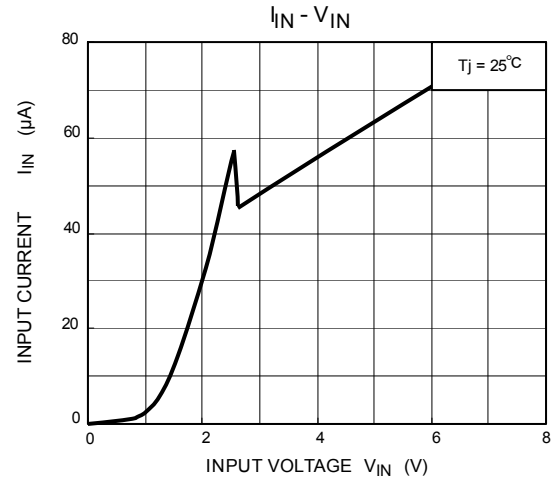
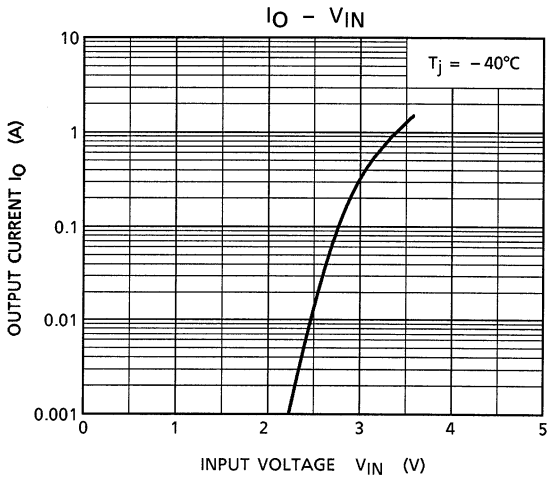
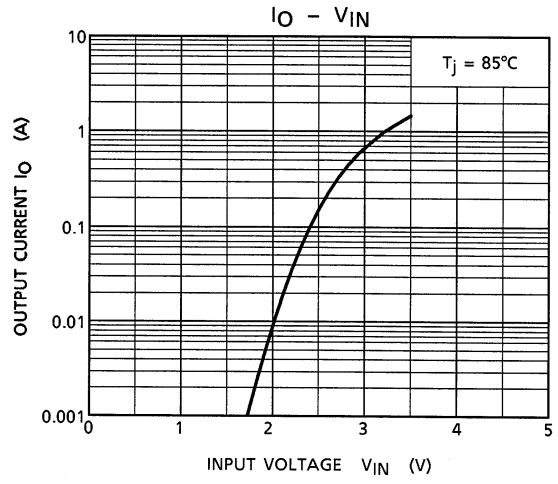
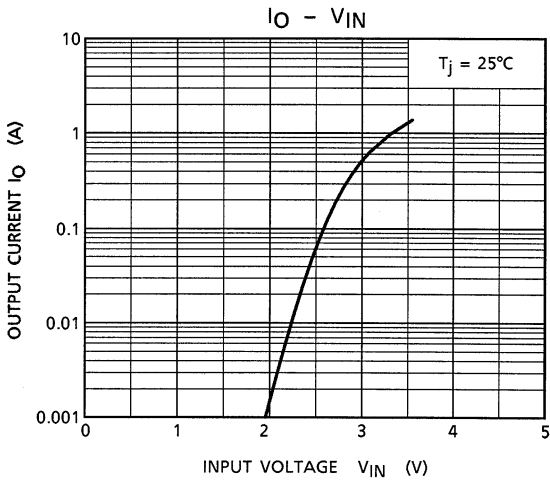

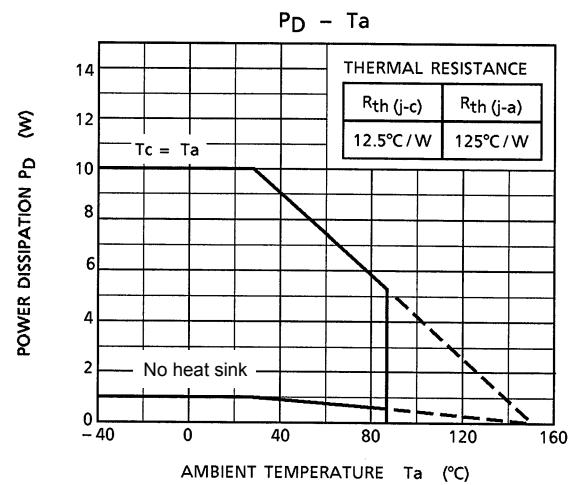
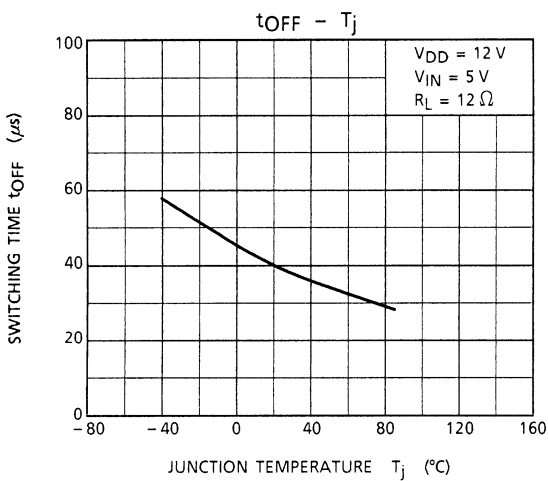
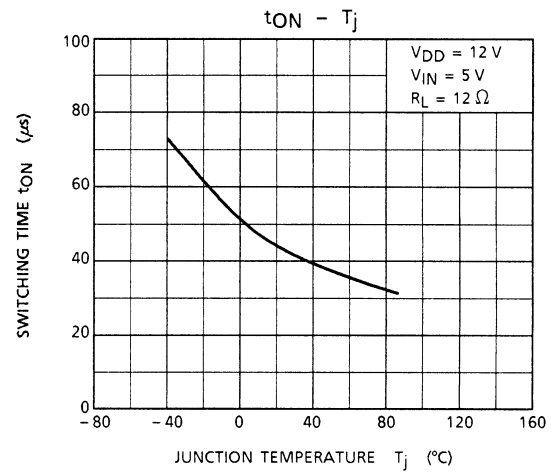
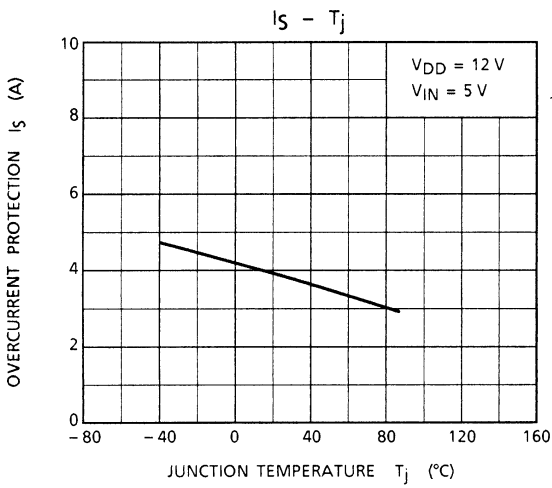
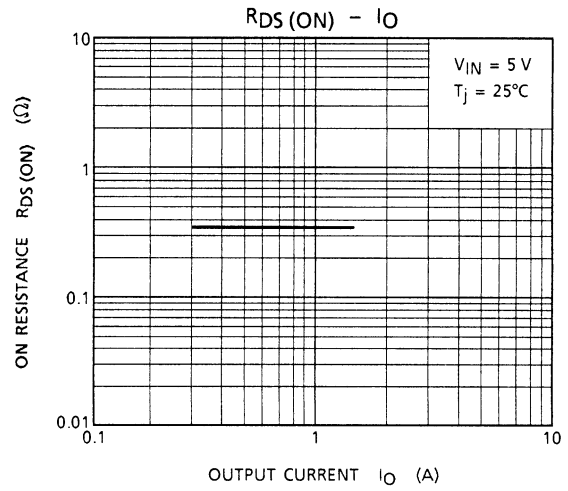
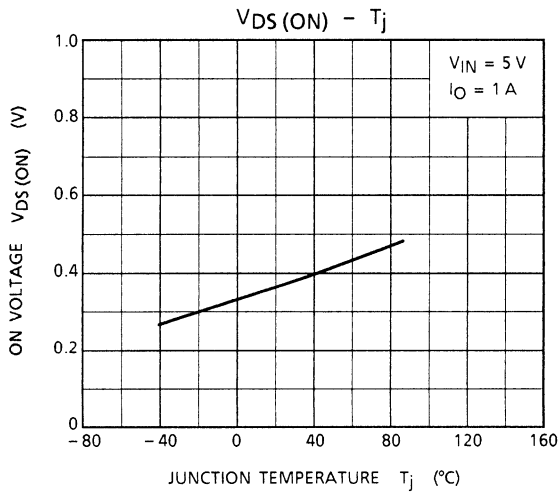

Package Dimensions

HSIP3_P_2.30B

Unit: mm

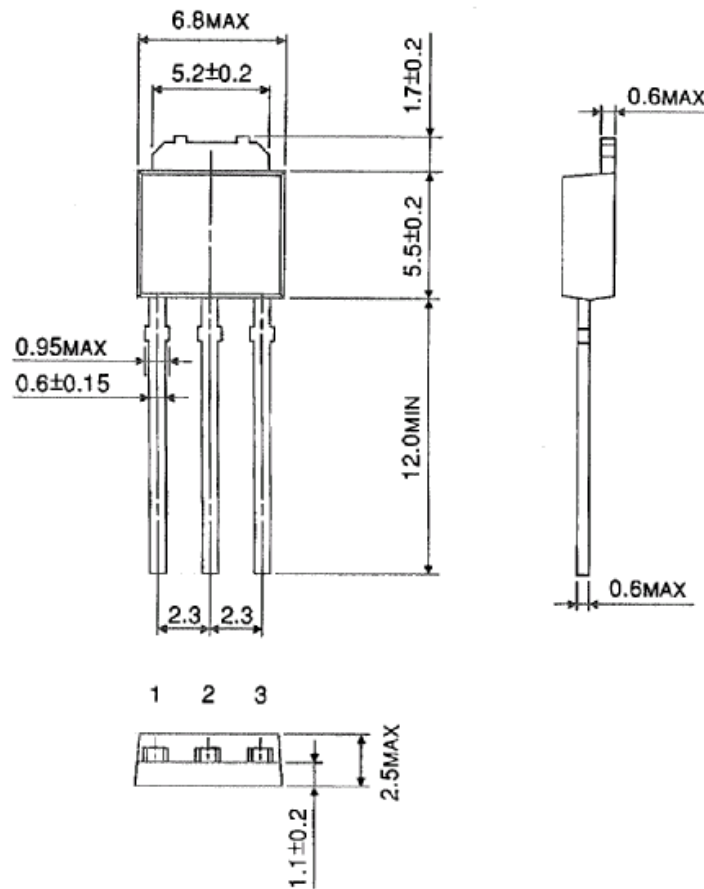

Weight: 0.36 g (typ.)

Package Dimensions

HSOP3_P_2.30A

Unit: mm

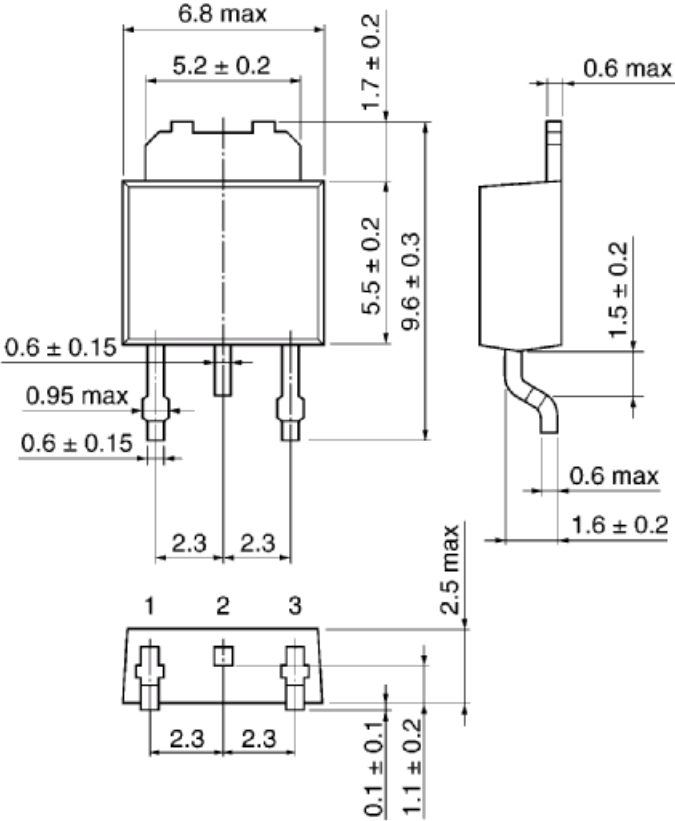

Weight: 0.28 g (typ.)

RESTRICTIONS ON PRODUCT USE

20070701-EN

- The information contained herein is subject to change without notice.
- TOSHIBA is continually working to improve the quality and reliability of its products. Nevertheless, semiconductor devices in general can malfunction or fail due to their inherent electrical sensitivity and vulnerability to physical stress. It is the responsibility of the buyer, when utilizing TOSHIBA products, to comply with the standards of safety in making a safe design for the entire system, and to avoid situations in which a malfunction or failure of such TOSHIBA products could cause loss of human life, bodily injury or damage to property.
In developing your designs, please ensure that TOSHIBA products are used within specified operating ranges as set forth in the most recent TOSHIBA products specifications. Also, please keep in mind the precautions and conditions set forth in the "Handling Guide for Semiconductor Devices," or "TOSHIBA Semiconductor Reliability Handbook" etc.
- The TOSHIBA products listed in this document are intended for usage in general electronics applications (computer, personal equipment, office equipment, measuring equipment, industrial robotics, domestic appliances, etc.). These TOSHIBA products are neither intended nor warranted for usage in equipment that requires extraordinarily high quality and/or reliability or a malfunction or failure of which may cause loss of human life or bodily injury ("Unintended Usage"). Unintended Usage include atomic energy control instruments, airplane or spaceship instruments, transportation instruments, traffic signal instruments, combustion control instruments, medical instruments, all types of safety devices, etc.. Unintended Usage of TOSHIBA products listed in this document shall be made at the customer's own risk.
- The products described in this document shall not be used or embedded to any downstream products of which manufacture, use and/or sale are prohibited under any applicable laws and regulations.
- The information contained herein is presented only as a guide for the applications of our products. No responsibility is assumed by TOSHIBA for any infringements of patents or other rights of the third parties which may result from its use. No license is granted by implication or otherwise under any patents or other rights of TOSHIBA or the third parties.
- Please contact your sales representative for product-by-product details in this document regarding RoHS compatibility. Please use these products in this document in compliance with all applicable laws and regulations that regulate the inclusion or use of controlled substances. Toshiba assumes no liability for damage or losses occurring as a result of noncompliance with applicable laws and regulations.